



YLI ELECTRONIC



# Mini Magnetic Lock

## Specification

Model	YM-40N	YM-60N	YM-60N-S
Dimension	70Lx36.5Wx24H(mm)	80Lx36.5Wx24.1H(mm)	80Lx36.5Wx24.1H(mm)
Armature plate	60Lx32Wx10H(mm)	75Lx32Wx10H(mm)	75Lx32Wx10H(mm)
Voltage	DC 12V/24V	DC 12V/24V	DC 12V/24V
Current	12V/160mA±10%; 24V/80mA±10%	12V/160mA±10%; 24V/80mA±10%	12V/160mA±10%; 24V/80mA±10%
Holding force	40kg(88Lbs)	60kg(120Lbs)	60kg(120Lbs)
Signal output	NO	NO	Lock signal(NO/COM)
Suitable for	File cabinet, Display cabinet	File cabinet, Display cabinet	File cabinet, Display cabinet
Cover finish	Anodized aluminum	Anodized aluminum	Anodized aluminum
Operating temp	-10~+55° (14-131F)	-10~+55° (14-131F)	-10~+55° (14-131F)
Weight	0.35kg	0.5kg	0.5kg

## Dimension(unit:mm)

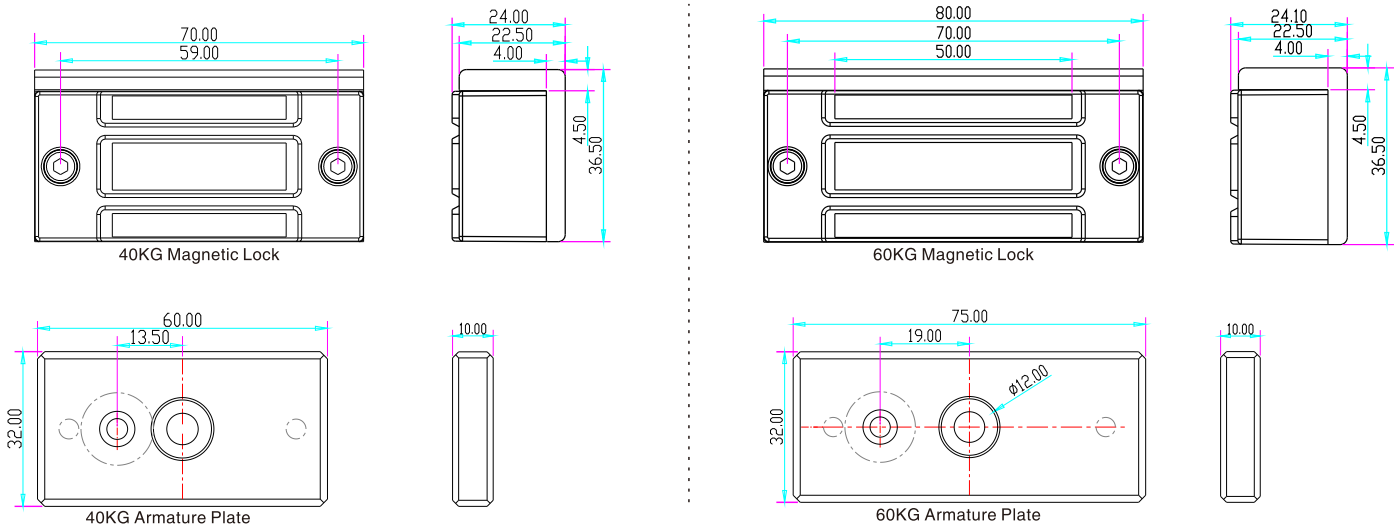

## Circuit board diagram

MINI Magnetic Lock

DC 12V Input

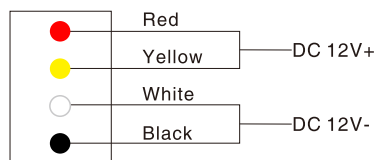

DC 24V Input

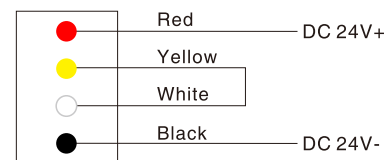

MINI Magnetic Lock with Signal Output

DC 12V Input

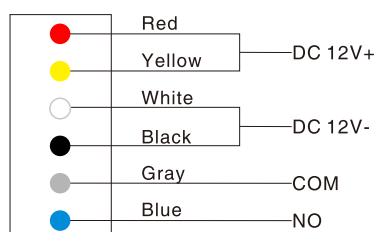

DC 24V Input

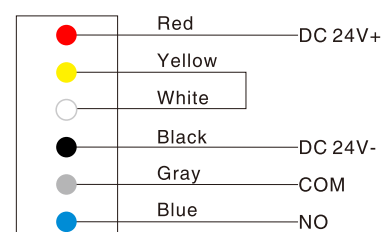

## Installation

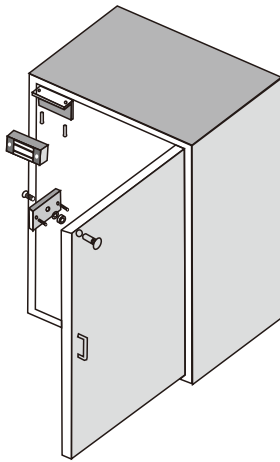

Demonstration of Standard Installation

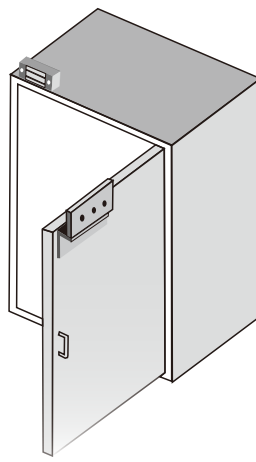

Demonstration of Z Bracket Installation

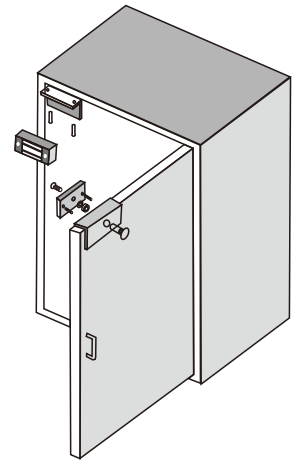

Demonstration of UL Bracket Installation

### ⚠ Caution:

- A. The screw of armature plate should not be fixed too tight. Proper elasticity should be guaranteed for the rubber ring so that the armature plate can adjust itself to the appropriate position.
- B. Please keep the surface of the lock clean, or the force will be reduced because of the dust, glue or scotch tape on it.
- C. Installation for magnetic lock with signal output: direction of armature plate, elastic nail shouldn't be on the same side with hole(see chart)

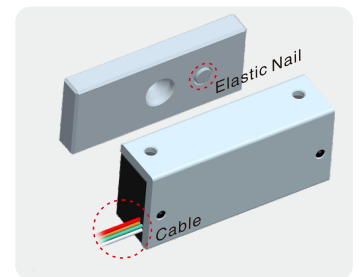

## Wiring Diagram

